

**8-/16-/24-Port 10/100TX 802.3at PoE +
2-Port Gigabit TP/SFP Combo Managed Ethernet Switches**

**FGSD-1008HPS/FGSW-1816HPS
FGSW-2624HPS/FGSW-2624HPS4**

Quick Installation Guide

Table of Contents

1. Package Contents	3
2. Requirements	4
3. Starting Web Management	5
3.1 Logging in to the Managed PoE Switch	6
3.2 Saving Configuration via Web	9
4. Terminal Setup	10
4.1 Logging on to Console.....	11
4.2 Configuring IP Address	12
4.3 Storing Current Switch Configuration	13
5. Recovering Back to Default Configuration.....	14
6. Customer Support	15

1. Package Contents

Thank you for purchasing PLANET 8-/16-/24-Port 10/100TX 802.3at PoE + 2-Port Gigabit TP/SFP Combo Managed Ethernet Switches, FGSD-1008HPS, FGSW-1816HPS, FGSW-2624HPS and FGSW-2624HPS4.

“Managed PoE Switch” mentioned in this quick installation guide refers to the above switches.

Open the box of the Managed PoE Switch and carefully unpack it. The box should contain the following items:

- The Managed PoE Switch x 1
- Quick Installation Guide x 1
- RS232 to RJ45 Console Cable x 1
- Rubber Feet x 4
- Two Rack-mounting Brackets with Attachment Screws x 1
- Power Cord x 1
- SFP Dust-proof Caps x 2

If any item is found missing or damaged, please contact your local reseller for replacement.

2. Requirements

- Workstations running Windows 7/8/10/11, macOS 10.12 or later, Linux Kernel 2.6.18 or later, or other modern operating systems are compatible with TCP/IP protocols.
- Workstations are installed with Ethernet NIC (Network Interface Card)
- **Serial Port Connection** (Terminal)
 - The above Workstations come with COM Port (DB9) or USB-to-RS232 converter.
 - The above Workstations have been installed with **terminal emulator**, such as Hyper Terminal included in Windows XP/2003 putty or tera term.
 - Serial cable -- one end is attached to the RS232 serial port, while the other end to the console port of the Managed PoE Switch.
- **Ethernet Port Connection**
 - Network cables -- Use standard network (UTP) cables with RJ45 connectors.
 - The above PC is installed with Web browser and JAVA runtime environment plug-in.



Note

It is recommended to use Google Chrome, Microsoft Edge or Mozilla Firefox to access the Managed PoE Switch. If the Web interface of the Managed PoE Switch is not accessible, please turn off the anti-virus software or firewall and then try it again.

3. Starting Web Management

The following shows how to start up the **Web Management** of the Managed PoE Switch. Note the Managed PoE Switch is configured through an Ethernet connection. Please make sure the manager PC must be set to the same **IP subnet address**.

For example, the default IP address of the Managed PoE Switch is **192.168.0.100**, then the manager PC should be set to **192.168.0.x** (where x is a number between 1 and 254, except 100), and the default subnet mask is 255.255.255.0.

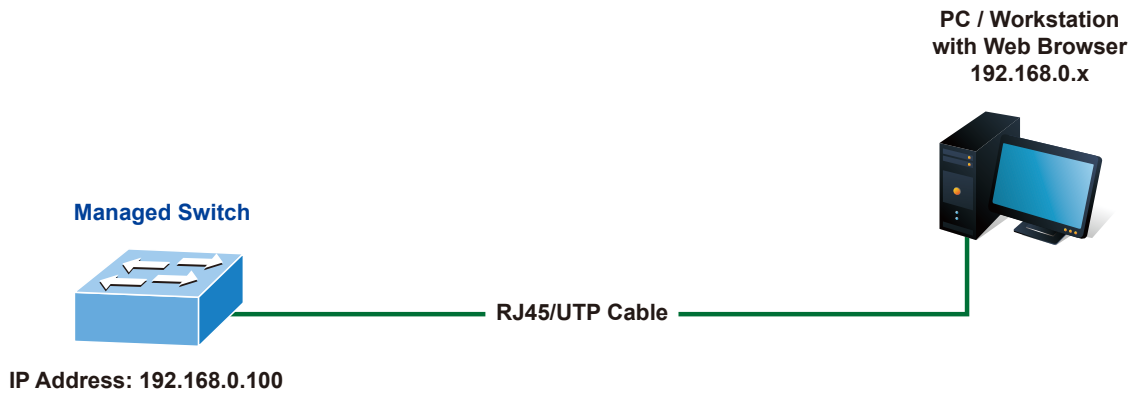

Figure 3-1: IP Management Diagram



Note

The following web screen is based on the FGSW-2624HPS; the display of the FGSW-2624HPS is the same as those of the FGSD-1008HPS, FGSW-1816HPS and FGSW-2624HPS4.

3.1 Logging in to the Managed PoE Switch

■ The following web screen is based on the firmware version before April 2024.

1. Use Internet Explorer 8.0 or above Web browser and enter IP address **http://192.168.0.100** (the factory default IP address or the one that you have just changed in console) to access the Web interface.
2. When the following dialog box appears, please enter the default user name and password **“admin”** (or the password you have changed via console). The login screen in Figure 3-2 appears.

Default IP Address: **192.168.0.100**
Default Username: **admin**
Default Password: **admin**

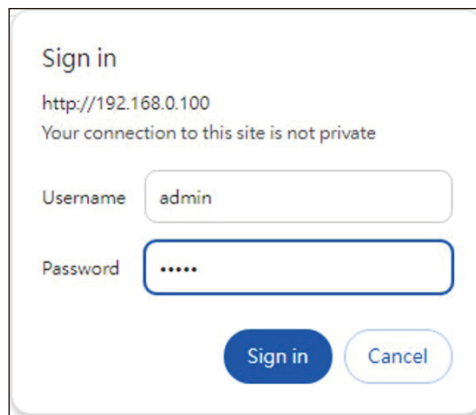

Figure 3-2: Login Screen

3. After entering the password, the main screen appears as Figure 3-3 shows.



Figure 3-3: Web Main Screen of Managed PoE Switch

The Switch Menu on the top and left of the Web page lets you access all the commands and statistics the Managed PoE Switch provides.

■ The following web screen is based on the firmware version of April 2024 or after. When the following dialog box appears, please enter the default user name "admin" and password. Refer to **Figure 3-5** to determine your initial login password.

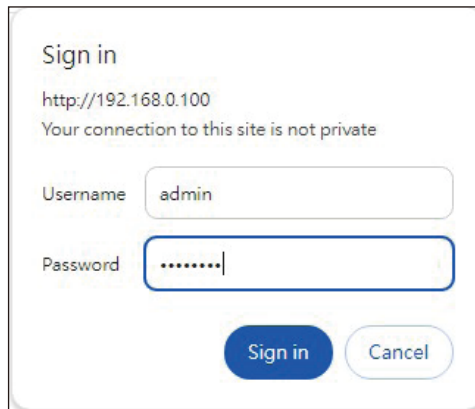

Figure 3-4: Login Screen

Default Username: **admin**
Default Password: **sw + the last 6 characters of the MAC ID in lowercase**

Find the MAC ID on your device label. The default password is "sw" followed by the last six lowercase characters of the MAC ID.

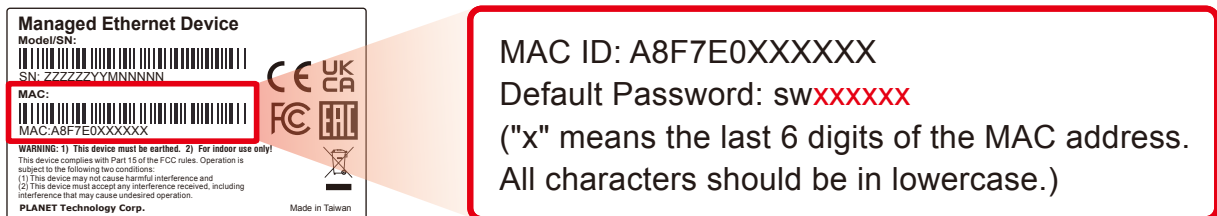

Figure 3-5: MAC ID Label

After logging in, you will be prompted to change the initial password to a permanent one.

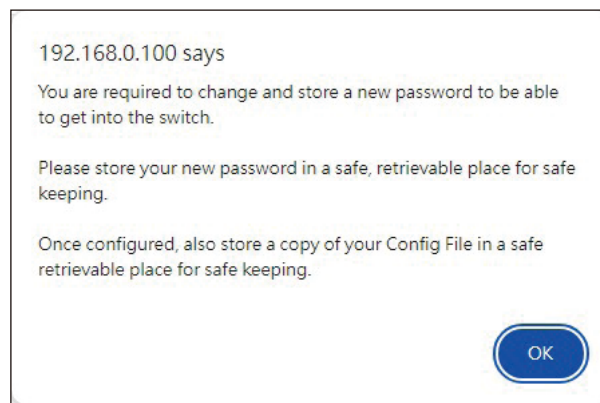

Figure 3-6: Message to change the password

Change Password

New Password	
Password	<input type="password"/> <input type="checkbox"/> show password
Retype Password	<input type="password"/>

The Password must contain 8 to 31 characters, including uppercase, lowercase and other symbols and other symbols. Symbols like | \ ; ? " & < > () and ` cannot be used. Please note, spaces (blanks) are not accepted.

Figure 3-7: Password Change Screen



Note

The Password must contain 8 to 31 characters, including uppercase, lowercase, numerals and other symbols. Symbols like | ` \ ; ? " & < > () and ` cannot be used. Please note spaces (blanks) are not accepted.

Once the password change is completed, re-enter the web interface using your new password.

Sign in

http://192.168.0.100
 Your connection to this site is not private

Username

Password

Figure 3-8: Login Screen

FGSW-2624HPS4

- FGSW-2624HPS4 Device Information
- ▶ System
- ▶ **PoE Configuration**
- ▶ Basic Configuration
- ▶ VLAN Configuration
- ▶ QoS Configuration
- ▶ ACL Configuration
- ▶ Security
- ▶ Advanced Features
- ▶ Monitoring

Figure 3-9: Switch Menu

Now, you can use the Web management interface to continue the Switch management or manage the Switch by console interface.

Please refer to the user's manual for more.

3.2 Saving Configuration via Web

To save all applied changes and set the current configuration as a startup configuration, the startup-configuration file will be loaded automatically across a system reboot.

1. Click the **Save** icon on the top Switch Menu bar.



Figure 3-10: Save Config -- Hot key

4. Terminal Setup

To configure the system, connect a serial cable to a COM port on a PC or notebook computer and to RJ45 type of serial port of the Managed PoE Switch.

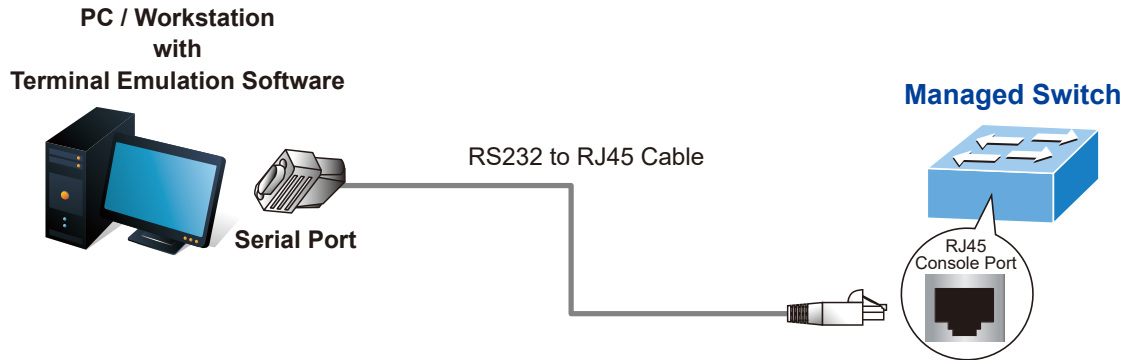

Figure 4-1: Console Connectivity

A terminal program is required to make the software connection to the Managed PoE Switch.

1. Run terminal program on the OS.
2. When the following screen appears, make sure that the COM port should be configured as:
 - ◆ Baud: 115200
 - ◆ Data bits: 8
 - ◆ Parity: None
 - ◆ Stop bits: 1
 - ◆ Flow control: None

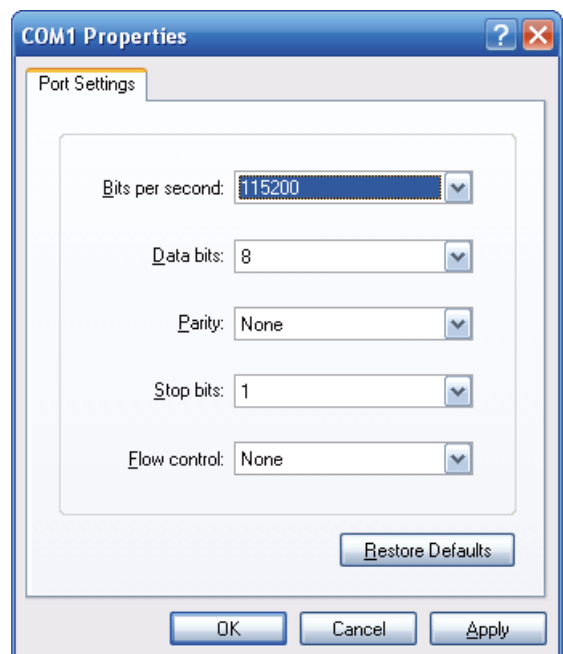

Figure 4-2: COM Port Configuration

4.1 Logging on to Console

Once the terminal is connected to the device, power on the Managed PoE Switch and the terminal will display "running testing procedures". Then, the following message asks to log in user name and password. The factory default user name and password are shown as follows and the login screen in Figure 4-3 appears.

■ The following web screen is based on the firmware version before April 2024.

```
Username: admin
Password: admin
Welcome to FGSW-2624HPS it is Thu Jan 1 08:01:11 UTC 1970
```

Figure 4-3: Console Login Screen

The user can now enter commands to manage the Managed PoE Switch. For a detailed description of the commands, please refer to the following chapters.



Note

1. For security reason, please change and memorize the new password after this first setup.
2. Only accept command in lowercase letter under console interface.

■ The following web screen is based on the firmware version of April 2024 or later.

The following message asks to log in username and password. The factory default username and password are shown as follows and the login screen in Figure 4-4 appears.

```
Username: admin
Password:
```

Figure 4-4: Console Login Screen

```
Default Username: admin
Default Password: sw + the last 6 characters of the MAC ID in lowercase
```

Find the MAC ID on your device label. The default password is "sw" followed by the last six lowercase characters of the MAC ID.

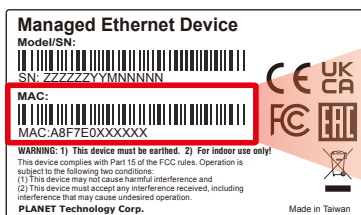

MAC ID: A8F7E0XXXXXX
Default Password: swxxxxxx
("x" means the last 6 digits of the MAC address.
All characters should be in lowercase.)

Figure 4-5: MAC ID Label

Enter the default username and password, then set a new password according to the rule-based prompt and confirm it. Upon success, press any key to return to the login prompt. Log in with "admin" and the "new password" to access the CLI.

```
Username:admin
Password:
Welcome to FGSD-1008HPS it is Thu Jan 1 08:07:26 UTC 1970

You are required to change and store a new password to be able to get into the switch.
Please store your new password in a safe, retrievable place for safe keeping.
Once configured, also store a copy of your Config File in a safe, retrievable place for safe keeping.
The Password must contain 8 to 31 characters, including uppercase, lowercase and numerals and other symbols.
ols like |'\;?"<>() and ` cannot be used. Please note, spaces (blanks) are not accepted.

Please Key in new password:
```

Figure 4-6: Password Change Screen



Note

The Password must contain 8 to 31 characters, including uppercase, lowercase, numerals and other symbols. Symbols like | ` \ ; ? " & < > () and ` cannot be used. Please note spaces (blanks) are not accepted.

4.2 Configuring IP Address

The Managed PoE Switch is shipped with default IP address shown below.

```
IP Address: 192.168.0.100
Subnet Mask: 255.255.255.0
```

To check the current IP address or modify a new IP address for the Switch, please use the procedures as follows:

■ Show the current IP Address

1. At the ">" prompt, enter "**show ip**".
2. The screen displays the current IP address as shown in Figure 4-7.

```
> show ip
IP Address: 192.168.0.100
Subnet Mask: 255.255.255.0
Default Gateway: 192.168.0.254
DNS Server:
DHCP Client: Disabled
```

Figure 4-7: IP Information Screen

■ Configuring IP Address

3. At the ">" prompt, enter the following command and press **<Enter>** as shown in Figure 4-8.

```
> config ip address 192.168.1.100  
> config ip submask 255.255.255.0
```

Figure 4-8: Configuring IP Address Screen

The previous command would apply the following settings for the Managed PoE Switch.

IP Address: **192.168.1.100**
Subnet Mask: **255.255.255.0**

4. Repeat step 1 to check if the IP address has changed.

4.3 Storing Current Switch Configuration

At the ">" prompt, enter the following command and press **<Enter>**.

```
> save
```

Figure 4-9: Saving Current Configuration Command Screen

If the IP is successfully configured, the Managed PoE Switch will apply the new IP address setting immediately. You can access the Web interface of the Managed PoE Switch through the new IP address.



Note

If you are not familiar with the console command or the related parameter, enter "?" anytime in console to get the help description

5. Recovering Back to Default Configuration

■ IP address has been changed or admin password has been forgotten –

To reset the IP address to the default IP address “**192.168.0.100**” or reset the login password to default value, press the hardware-based **reset button** on the front panel for about **5 seconds**. After the device is rebooted, you can log in to the management Web interface within the same subnet of 192.168.0.xx.

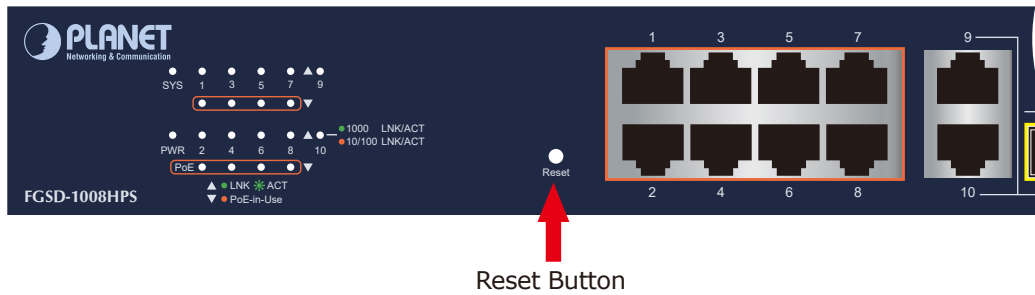

Figure 5-1: FGSD-1008HPS Reset Button

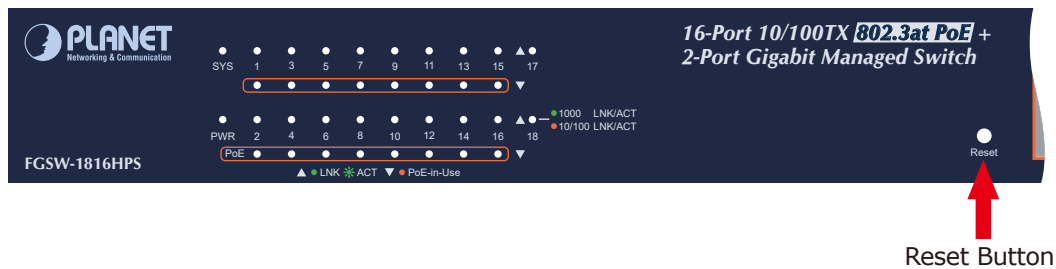

Figure 5-2: FGSW-1816HPS Reset Button

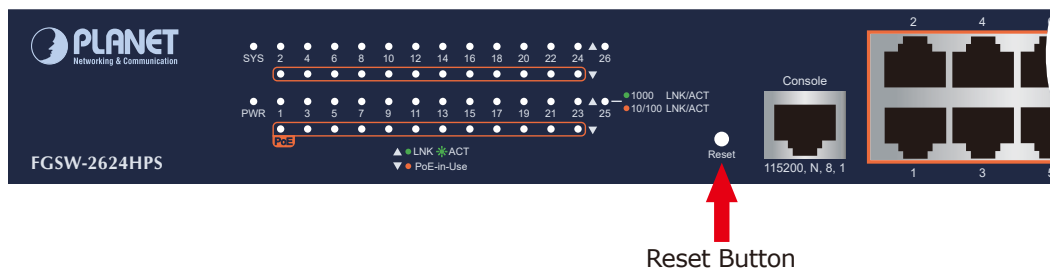

Figure 5-3: FGSW-2624HPS Reset Button

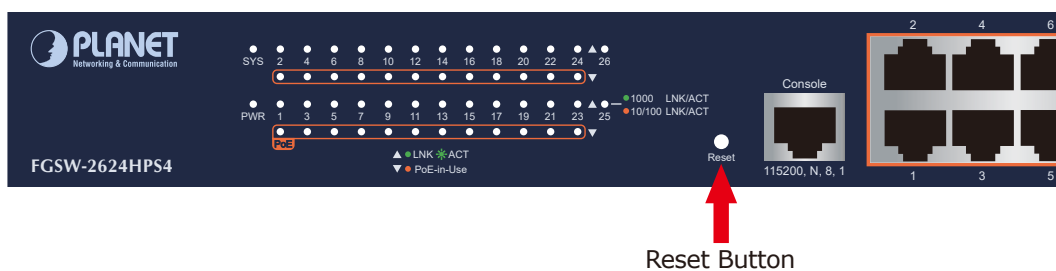

Figure 5-4: FGSW-2624HPS4 Reset Button

6. Customer Support

Thank you for purchasing PLANET products. You can browse our online FAQ resource and User's Manual on PLANET Web site first to check if it could solve your issue. If you need more support information, please contact PLANET switch support team.

PLANET online FAQs:

<http://www.planet.com.tw/en/support/faq>

Switch support team mail address:

support@planet.com.tw

FGSD-1008HPS(V3), FGSW-1816HPS(V3), FGSW-2624HPS(V4) and FGSW-2624HPS4(V3)

User's Manual:

<https://www.planet.com.tw/en/support/downloads?method=category&c1=&p=&type=3>



(Please select your switch model name from the drop-down menu of Product Model.)

Copyright © PLANET Technology Corp. 2024.

Contents are subject to revision without prior notice.

PLANET is a registered trademark of PLANET Technology Corp.

All other trademarks belong to their respective owners.